



Loctite® Integrated Semi-Automatic Dispenser Dual Channel with Low Level Sensor

Part Numbers

1390322, 0 – 1 Bar
1390321, 0 – 7 Bar

Table of Contents

1. PLEASE OBSERVE THE FOLLOWING	3
1.1 EMPHASIZED SECTIONS	3
2. DESCRIPTION	3
2.1 OPERATION	3
2.3 ITEMS SUPPLIED.....	5
2.4 OVERALL DIMENSIONS.....	5
2.5 CONTROL PANEL (FRONT & BACK OF CONTROLLER).....	6
3. TECHNICAL DATA	7
3.1 SPECIFICATIONS	7
4. INSTALLATION	8
4.1 UNPACKING AND INSPECTION.....	8
4.2 ENVIRONMENTAL AND OPERATING CONDITIONS	8
4.3 CONNECTING THE UNIT	8
5. OPERATION	9
5.1 FUNCTION OF THE CONTROL PANEL:	9
5.2 XS1 CONNECTION SIGNAL:	10
5.3 START UP THE SYSTEM:	10
5.4 RUN: AUTO MODE.....	10
5.5 RUN: MANUAL MODE	10
5.6 RUN: CONTINUOUS MODE.....	11
5.7 SET: TIME (AUTO) MODE	11
5.8 SET: DELAY (AUTO) MODE	11
5.9 SET: OUTPUT MODE	11
5.10 SET: LOW LEVEL MODE	12
5.11 SET: LOCK-OUT MODE.....	12
5.12 ADJUST THE LEVEL SENSOR	12
6. TROUBLESHOOTING	13
7. CARE AND MAINTENANCE	14
7.1 CARE.....	14
7.2 MAINTENANCE	14
8. DOCUMENTATION	15
8.1 ELECTRICAL SCHEMATIC.....	15
8.2 PIN CONNECTIONS.....	16
9. ACCESSORIES, SPARE PARTS & SYSTEM COMPONENTS SOLD SEPARATELY	16

1. Please Observe The Following

1.1 Emphasized Sections

Warning!

Refers to safety regulations and requires safety measures that protect the operator or other persons from injury or danger to life.

Caution!

Emphasizes what must be done or avoided so that the unit or other property is not damaged.

Notice:

Gives recommendations for better handling of the unit during operation or adjustment as well as for service activities.

Warning!

Never fill the product directly into the Product Reservoir! Insert only products packaged in original Loctite® containers!

2. Description

2.1 Operation

The Loctite® Integrated Semi-Automatic Dispenser combines a dual channel dispense controller and reservoir into a single system. The controller provides 2 independent digital timing channels that provide control of 2 pneumatic outputs. These outputs can be used to control dispense valves, advancing slides or any other pneumatic device. The controller can be actuated either by a footswitch, fingerswitch or external signal. It is capable of operating in a manual or time mode for dot or bead dispensing applications. The reservoir can accommodate 50ml, 250 ml, 500 gram, 1 liter, 2 kg and 200 gram adhesive packages which deliver adhesive to dispensing valves. The system is also equipped with low level sensor which can notify the operator that the adhesive package needs to be replaced.

- The Integrated Semi-Automatic Dispenser 1390322 is equipped with a precision pressure regulator 0-1 bar (0-14 PSI).
- The Integrated Semi-Automatic Dispenser 1390321 is equipped with a pressure regulator 0-7 bar (0-100 PSI).

With the Integrated Semi-Automatic Dispense System, anaerobic, UV Curing and cyanoacrylate adhesive can be dispensed.

The capacity of the Integrated Semi Automatic Dispenser is:

- 500 gr. bottle for CA Product
- 250 ml bottle for Anaerobics
- Bottle with a Ø 124mm and a height of 250mm
- 1 lb. bottle
- 1 Liter bottle
- 2kg bottle

2.2 Theory of Operation

The Loctite® Integrated Semi-Automatic Dispenser is connected to an external pneumatic supply. It regulates the adjusted dispensing pressure and controls the dispensing during the selected dispensing time.

An uncovered bottle of LOCTITE® product is placed directly into the integrated reservoir, the tube is inserted into the product, and the reservoir lid is clamped in place.

It is then pressurized using clean, filtered dry air. Air within the reservoir will push down on the liquid in the bottle and force it through the product feedline to the dispensing valve.

The amount of product dispensed is controlled by three main factors:

- Amount of pressure in the reservoir
- Length of time the dispensing valve remains open
- Dispensing needle size

Time Mode:

1. Press the footswitch to activate the system.
2. The dispensing timer will be activated and start to dispense with preset dispensing time.
3. After the dispensing timer has reached the preset dispensing time, the dispensing will be stopped.

Manual Mode:

1. Press the footswitch to activate the system.
2. The system will start to dispense and the dispensing timer will start to count the dispensing time.
3. Once the footswitch is released, the dispensing will be stopped.

Additional Features:

EMPTY Signal:

If the reservoir is empty the contact of the level sensor opens. Three different types of Low Level Signal can be selected to indicate.

Mode 1: Digital Only

Mode 2: Digital + Lamp

Mode 3 : Digital + System Stop

READY Signal :

If the dispensing cycle is finished and the reservoir is not empty, a contact is closed.

Both EMPTY and READY signals are available as dry contacts at the XS1 start interface for optional connection to a higher-ranking controller of a warning light.

Except selected “System Stop” mode, the start of dispensing cycle is not locked when EMPTY is indicated.

! Caution!

Pay attention if cyanoacrylate is dispensed – Air in the feedline results in curing of the product!

2.3 Items Supplied

- Integrated Semi-Automatic Dispenser, Dual Channel, 0-1 Bar, Order No. 1390322 or
- Integrated Semi-Automatic Dispenser, Dual Channel, 0-7 Bar, Order No. 1390321
- Footswitch (1)
- Reservoir Fitting (1)
- Bottle Nesting Basket (1)
- Anti-Bubbler Fitting and Tubing Kit
- ¼" NPT to 6mm tube connector (1)
- Power Adapter with Cord (1)
- Operating Manual CD (1)

2.4 Overall Dimensions

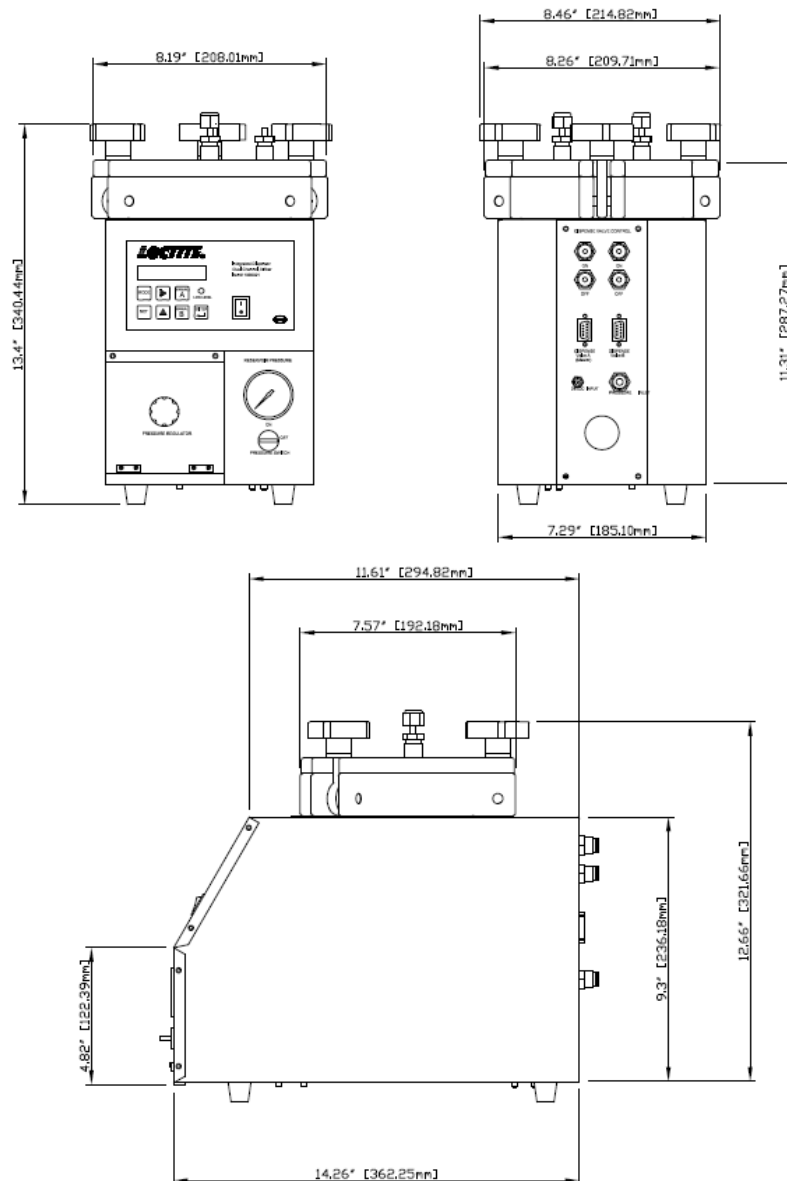

2.5 Control Panel (Front & Back of Controller)

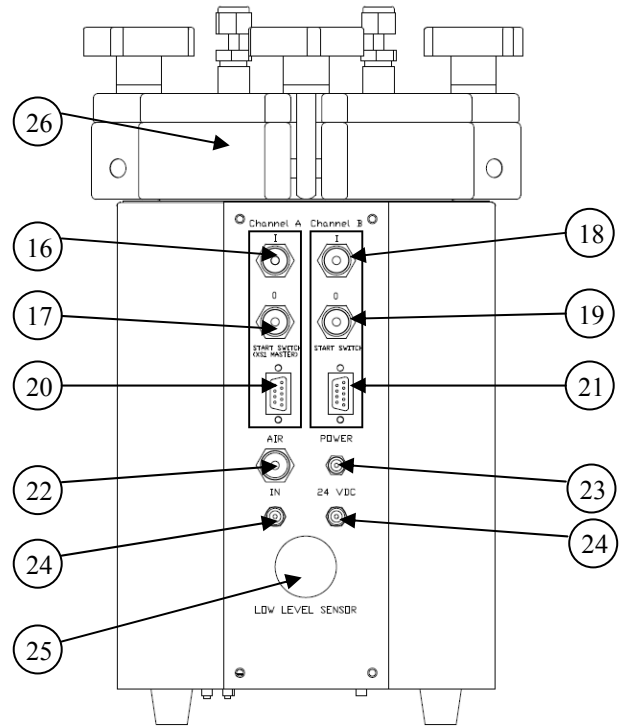
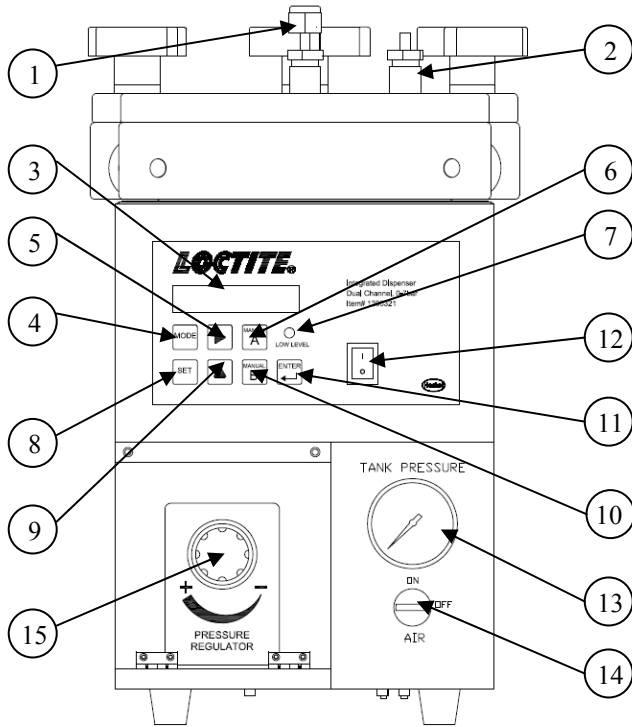

1. Reservoir Fitting
2. Valve Pressure Relief
3. Display
4. Mode Switch
5. Right Arrow Switch
6. Manual Switch for Channel A
7. Low Level Error LED Light
8. Set Switch
9. Up Arrow Switch
10. Manual Switch for Channel B
11. Enter Switch
12. Main Power On/Off Switch
13. Tank Pressure Gauge

14. Air Pressure On/Off Switch
15. Tank Pressure Regulator
16. Channel A On Output
17. Channel A Off Output
18. Channel B On Output
19. Channel B Off Output
20. XS1 Channel A (Master)
21. XS1 Channel B
22. Air Pressure In
23. 24VDC Power In
24. Silencer
25. Low Level Sensor
26. Reservoir

3. Technical Data

3.1 Specifications

Attribute		Value		
Time Range		0 – 99.99 seconds		
Air Input*		Clean, dry air not to exceed 125 psig (8.5 bar), and filtered with a maximum of 50 micron		
Regulation Range of the Pressure Regulator		<table border="1"> <tr> <td>1390322 0 – 2 bar (0 – 28 PSI)</td> <td>1390321 0 – 7 bar (0 – 100 PSI)</td> </tr> </table>	1390322 0 – 2 bar (0 – 28 PSI)	1390321 0 – 7 bar (0 – 100 PSI)
1390322 0 – 2 bar (0 – 28 PSI)	1390321 0 – 7 bar (0 – 100 PSI)			
Pressure Indication		<table border="1"> <tr> <td>0 – 1 bar (0 – 14 PSI)</td> <td>0 – 7 bar (0 – 100 PSI)</td> </tr> </table>	0 – 1 bar (0 – 14 PSI)	0 – 7 bar (0 – 100 PSI)
0 – 1 bar (0 – 14 PSI)	0 – 7 bar (0 – 100 PSI)			
Power		Supply: 110 – 240 V / 50 – 60 Hz Internal: 24 VDC Power Connection: Includes plug ends for North America/Japan, Continental Europe, UK, Australia and China.		
Dimensions	Width	7.29" (186mm)		
	Depth	14.26" (363mm)		
	Height	13.4" (341mm)		
Weight		15.4lb (7 kg)		
Operation Temperature		+ 10°C to + 40°C (+50°F to +104°F)		
Storage Temperature		- 10°C to + 60°C (+14°F to +140°F)		

* If the required air quality is not achieved, install a Loctite® filter regulator. In the US order a 5 µm filter using part number 985397. In Europe or Asia, order a 10 µm filter using part number 97120.

4. Installation

4.1 Unpacking and Inspection

Carefully remove the system from its shipping carton and inspect it for any signs of damage. Any damage should be reported immediately to the carrier. Refer to the list of supplied parts (see page 4) and compare to the contents. Report any missing or damaged parts promptly. In North America contact 1-800-LOCTITE (562-8483) and for all other locations contact your local Henkel customer service.

4.2 Environmental and Operating Conditions

- Keep the pressure hose as short as possible. Short switch-on and switch-off time for the dispensing valve are within reach.
- Keep product feed lines as short as possible. The shorter the feedline the smaller the specific resistance and the lower the dispensing pressure can be. Avoid kinking.
- In any case, the pressure hose and product feedline should not be longer than 2 m.
- Do not use inflexible hoses and feed lines, so that unnecessary loads on the fittings will be avoided.
- Keep all fitting tight.
- No direct sunlight; no UV light.
- No condensing humidity.
- No splashing water.

4.3 Connecting the Unit

- Use only the cable and hose sets supplied.
- Connect power adapter with cord supplied to 24VDC power in connection (23).
- Connect air pressure supply to pneumatic connection (22).

5. Operation

5.1 Function of the Control Panel:



Switch (4):

Switching different mode as below cycle:

Run: Auto > Run: Manual > Run: Continuous > Set: Time (Auto) > Set: Delay (Auto) > Set: Output > Set: Low Level > Set: Lock-Out



Switch (8)

Set the data in all "SET: XXXX" mode.



Switch (5):

For parameter digit position change. Digit position will move 1 digit to the right.



Switch (9):

For numbering change. Change from "0 – 9" or switching each option by each press.



Switch (11):

To confirm the setting and save.



Switch (6):

In "Run: Manual" mode, press and hold for manual purging the adhesive for Channel A without displaying or changing parameters.



Switch (10):

In "Run: Manual" mode, press and hold for manual purging the adhesive for Channel B without displaying or changing parameters.



LOW LEVEL LED Light (7):

Light to show when the adhesive is in low level.

5.2 XS1 Connection Signal:

The system can be auto detecting when the footswitch(s) plug onto the system.

Only XS1 Channel A (Master) Footswitch plugged:

The footswitch can control both output of Channel A and Channel B and start at the same time.

Only XS1 Channel B Footswitch plugged:

The footswitch can only control the output of Channel B.

Both XS1 Channel A (Master) and XS2 Channel B Footswitch plugged:

The footswitch will control their own channel and can be started up at different times.

5.3 Start Up the System:

1. Turn the “POWER” on (the position marked “ \uparrow ”) (12). The display (3) will turn on.
2. If necessary, open the valve or regulator that controls the air inlet to supply pneumatic pressure to the system.
3. Turn the “AIR” on (the position \oplus) (14).



5.4 Run: Auto Mode

Engage the footswitch(s) to start the cycle. The dispensing will begin immediately and continue until the system times out.

Notice:



Channel A and Channel B outputs are active only when the “OUTPUT” setting is set to “ON”. (Refer to section 5.8)

5.5 Run: Manual Mode

Press the  or  to purge the adhesive manually without displaying or saving parameters.

5.6 Run: Continuous Mode

Engage the footswitch(s) to start dispensing and hold until the dispensing cycle is complete. When the footswitch is released, the dispensing will end immediately.





The display on the system will show the last dispensing time. If needed, press  and  to store the dispensing time to “Run: Auto” Mode.

Notice:

Channel A and Channel B outputs are active only when the “OUTPUT” setting is set to “ON”. (Refer to section 5.8)





5.7 Set: Time (Auto) Mode

Set the dispensing time for Channel A and Channel B in “Run: Auto” mode.

1. Press , the left most digit for Channel A will start to flash.
2. Press  for numbering change on the flashing digit (0.01 – 99.99).
3. Press  to move the flashing digit 1 digit to right.
4. Press  again to switch from Channel A and Channel B.
5. After completed setting, press  to save and exit.





5.8 Set: Delay (Auto) Mode

Set the delay time of Channel A and Channel B after engaged the footswitch in “Run: Auto” mode.



1. Press , the left most digit for Channel A will start to flash.
2. Press  for numbering change on the flashing digit (0.01 – 99.99).
3. Press  to move the flashing digit 1 digit to right.
4. Press  again to switch from Channel A and Channel B.
5. After completed setting, press  to save and exit.

5.9 Set: Output Mode

Enable or Disable the output for each channel.

1. Press , the setting for Channel A will start to flash.
2. Press  to switch between “ON” or “OFF”.
3. Press  again to switch from Channel A and Channel B.
4. After completed setting, press  to save and exit.

5.10 Set: Low Level Mode

1. Press , the setting for Low Level mode start to flash.
2. Press  for switching between “OFF”, “LAMP” and “LAMP + STOP”.
3. After completed setting, press  to save and exit.

Notice:

OFF: Only digital output from XS1



LAMP: Digital output from XS1 + LED Light on control panel

LAMP + STOP: Digital output from XS1 + LED Light on control panel + System Stop

Notice:

The level sensor MUST be adjusted according to the type of product used, the size of the bottle, and orientation of the basket with spacers, in order to function properly.

5.11 Set: Lock-Out Mode

1. Press , the setting for Lock-Out mode start to flash.
2. Press  for switch between “ON” and “OFF”.
3. After completed setting, press  to save and exit.

Notice:

Lock-Out Mode “ON” means all setting in the system can’t be change by pressing  button. Otherwise “Setting Locked Call Supervisor” will show on the display.

Press both  +  to change the setting when Lock-Out Mode is “ON”.

5.12 Adjust the Level Sensor

Before adjusting the Level Sensor

1. Empty a bottle of the product you use.
2. Leave as much residue in the bottle as is required in order to prevent air getting into the product feedline.
3. Insert the product bottle. For small bottles use bottle nesting block.
4. Check that the product bottle inserted into the bottle nesting block is pressed against the level sensor. Only then the correct adjustment of the level sensor is possible.

Procedure to Adjust the Level Sensor:

1. Turn the system power “ON”.
2. Remove the metal screw from the level sensor.
3. With an electrician’s screwdriver, find the point at which the sensor switches to the condition inactive. The LED “OFF”.
4. Check this adjustment with a full bottle and an empty bottle.

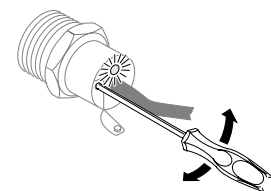

Notice:

The correct adjustment is exactly the point when the sensor switches “OFF”.

Do not go beyond that point!

6. Troubleshooting

Symptom	Possible Causes	Corrections
The digital display does not light.	<ul style="list-style-type: none"> - No power voltage present. - Powers switch 12 in position O (OFF). - Power adaptor with cord is defective. - Control unit is defective 	<ul style="list-style-type: none"> • Check the power voltage. • Switch power switch to position I (ON). • Replace power adapter with cord. • Call Henkel Service.
No needle movement on the pressure gauge.	<ul style="list-style-type: none"> - No air pressure present. - Pressure gauge 13 defective. - Pressure regulator 15 defective. 	<ul style="list-style-type: none"> • Check depressurizing valve 14 and pneumatic supply. • Replace gauge. • Replace regulator.
LED does not light.	<ul style="list-style-type: none"> - LED defect. 	<ul style="list-style-type: none"> • When the controller is operational, the unit can be used until repaired by Henkel Service.
No start signal.	<ul style="list-style-type: none"> - Plug on the XS1 (20 or 21) : Start 9 is loose. - Footswitch defective. 	<ul style="list-style-type: none"> • Switch the power switch to the position O (OFF). Tighten the screws of the plug. Switch the power switch to the position I (ON). • Replace the Footswitch.
No product, too little or too much product.	<ul style="list-style-type: none"> - Dispensing pressure not set correctly. - Pressure hose not properly connected. - Luer-Lock tip cap not removed. - Dispensing needle clogged, too small or too large - Dispensing valve not correctly connected or defective. - Product reservoir not switched on. - Product reservoir is empty. 	<ul style="list-style-type: none"> • Adjust dispensing pressure setting. • Connect air pressure hose correctly. • Replace Luer-Lock tip cap with a dispensing needle. • Replace dispensing needle. • Check the dispensing valve. • Check product reservoir. • Refill product reservoir.
The desired pressure is not achieved.	<ul style="list-style-type: none"> - Supply pressure inadequate. 	<ul style="list-style-type: none"> • Increase the supply pressure (min 0.5 bar above reservoir pressure).
Air bubbles in the product.	<ul style="list-style-type: none"> - Product reservoir is empty. - Product hose not correctly connected. - Dispensing valve not correctly connected or defective. - Product reservoir pressure is too high. 	<ul style="list-style-type: none"> • Refill product reservoir. • Connect product hose correctly. • Check the dispensing valve (see instruction manual for dispensing valve). • Lower pressure, longer dispensing time.
Pressurized air escapes between reservoir housing and reservoir lid.	<ul style="list-style-type: none"> - Reservoir knob is not tightened. - O-Ring leaky. 	<ul style="list-style-type: none"> • Tighten the reservoir knob. • Grease or replace the O-Ring.
Pressurized air escapes at the product connection 1.	<ul style="list-style-type: none"> - Union nut on the product connection not tightened. 	<ul style="list-style-type: none"> • Carefully tighten the union nut.

7. Care and Maintenance

7.1 Care

- Occasionally the o-ring at the reservoir lid should be lubricated with the enclosed silicone grease. This will prolong the life of the o-ring.

 **Notice:** Clean hands after application of grease to assure surfaces to be bonded are clean. Otherwise bonding might fail.

- Clean the sensor surface as required.
- Both the bottle surface and the sensor surface must be free of condensed moisture!

7.2 Maintenance

- Check the reservoir knobs and the product feedline on the regular basis. If there is any sign of cracks, replace them!
- Clean, dry, filtered air must be used. If it is not, the solenoids on the controller will be fouled over time.

 **Notice:** If the required air quality is not achieved, install a Loctite[®] filter regulator. In the US order a 5 µm filter using Part Number 985397. In Europe or Asia, order a 10 µm filter using Part Number 97120.

8. Documentation

8.1 Electrical Schematic

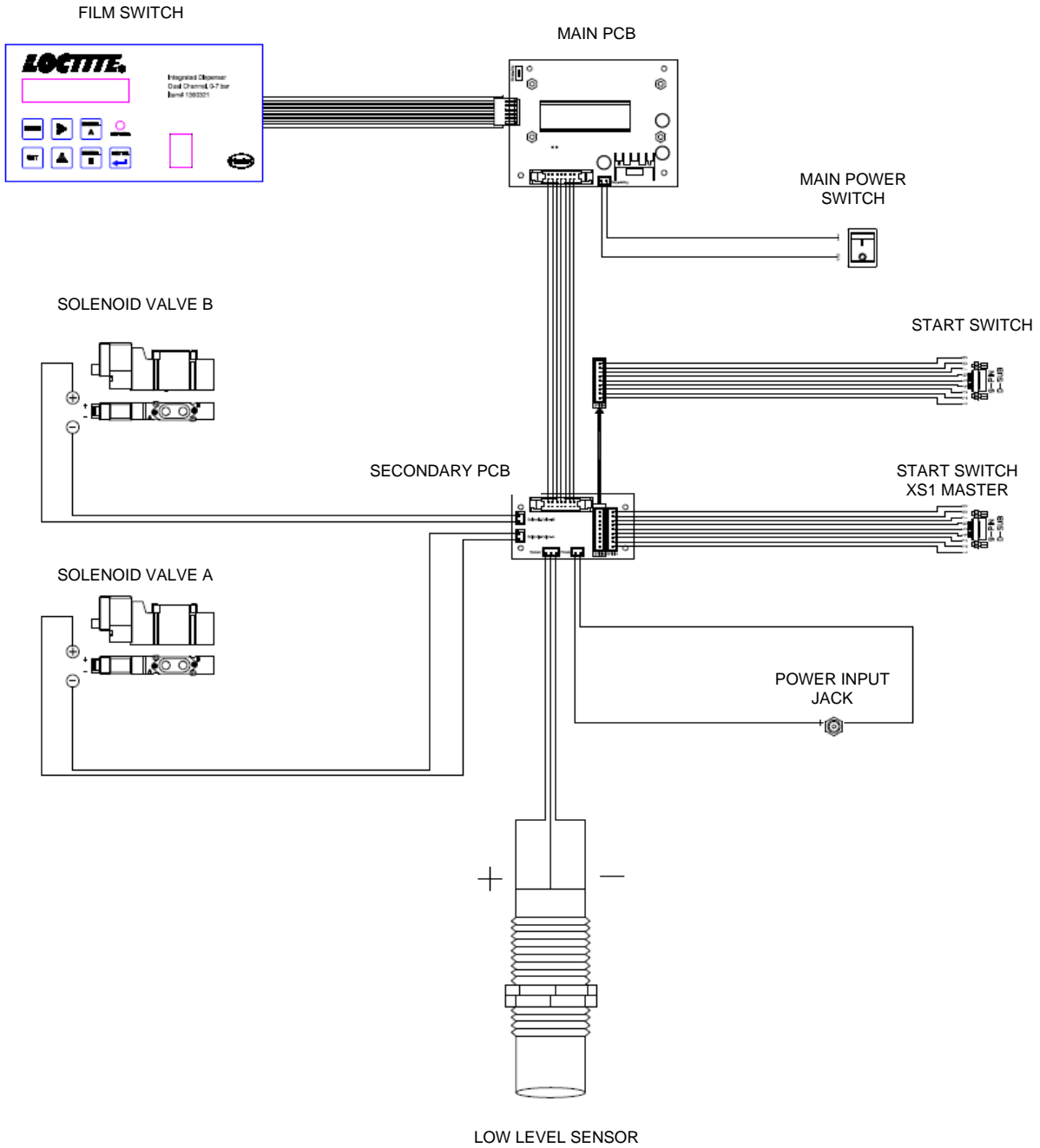

8.2 Pin Connections

XS1 Start via Footswitch, additional Empty Signal and Ready Signal.

Warning!

Never connect external voltage on pin 1 or pin 9!

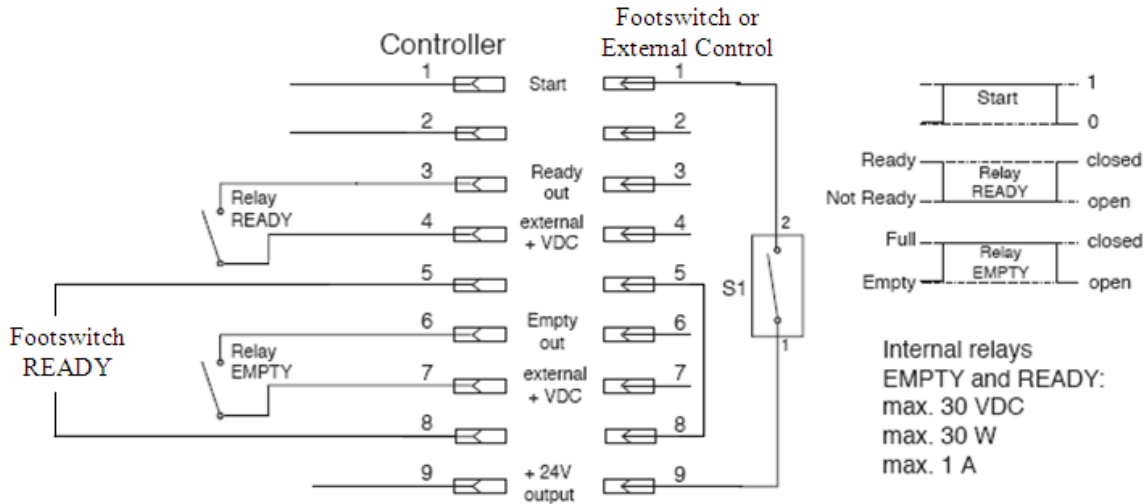

9. Accessories, Spare Parts & System Components Sold Separately

Loctite Item Number	Description
Accessories	
985397	Loctite® Air Filter, Regulator, Gauge
Spare Parts	
8900064	Reservoir Tank Fitting, 1/4 inch NPT x 1/4 inch Tubing
97201	Footswitch
97972	1/4 inch O.D. Black PE Teflon Lined Fluid Feedline Tubing (33 feet length)
981880	Tank Lid O-Ring for Reservoir
992641	Pressure Safety Relief Valve
984687	Anti-Bubbler Kit, 2 Adapters & 2 Sleeves
997569	Silicone Grease, 6 Gram Tube
System Components Sold Separately	
97113	Stationary Dispense Valve, (1/4" Feedline)
97114	Stationary Dispense Valve, (3/8" Feedline)
98009	Light Cure Dispense Valve
98013	Cyanoacrylate Dispense Valve
97130	ErgoLoc Handheld CA Dispense Valve
1176444	Pistol Grip Trigger

EQUIPMENT WARRANTY

For Loctite® Integrated Semi Automatic Dispenser

Henkel expressly warrants that all products referred to in this Instruction Loctite® Integrated Semi Automatic Dispenser (hereafter called “Products”) shall be free from defects in materials and workmanship. Liability for Henkel shall be limited, at its option, to replacing those Products which are shown to be defective either in materials or workmanship or to credit to the purchaser the amount of the purchase price thereof (plus freight and insurance charges paid therefore by the user). The purchaser’s sole and exclusive remedy for breach of warranty shall be such replacement or credit.

A claim of defect in materials or workmanship in any Products shall be allowed only when it is submitted to Henkel in writing within one month after discovery of the defect or after the time the defect should reasonably have been discovered and in any event, within twelve months after the delivery of the Products to the purchaser. No such claim shall be allowed in respect of Products which have been neglected or improperly stored, transported, handled, installed, connected, operated, used or maintained or in the event of unauthorized modification of the Products including, where products, parts or attachments for use in connection with the Products are available from Henkel, the use of products, parts or attachments which are not manufactured by Henkel.

No Products shall be returned to Henkel for any reason without prior written approval from Henkel. Products shall be returned freight prepaid, in accordance with instructions from Henkel.

NO WARRANTY IS EXTENDED TO ANY EQUIPMENT WHICH HAS BEEN ALTERED, MISUSED, NEGLECTED, OR DAMAGED BY ACCIDENT, OR IF THE SYSTEM USED TO DISPENSE ANY LIQUID MATERIAL OTHER THAN LOCTITE® PRODUCTS.

EXCEPT FOR THE EXPRESS WARRANTY CONTAINED IN THIS SECTION, HENKEL MAKES NO WARRANTY OF ANY KIND WHATSOEVER, EXPRESS OR IMPLIED, WITH RESPECT TO THE PRODUCTS.

ALL WARRANTIES OF MERCHANTABILITY, FITNESS FOR A PARTICULAR PURPOSE, AND OTHER WARRANTIES OF WHATEVER KIND (INCLUDING AGAINST PATENT OR TRADEMARK INFRINGEMENT) ARE HEREBY DISCLAIMED BY HENKEL AND WAIVED BY THE PURCHASER.

THIS SECTION SETS FORTH EXCLUSIVELY ALL OF LIABILITY FOR HENKEL TO THE PURCHASER IN CONTRACT, IN TORT OR OTHERWISE IN THE EVENT OF DEFECTIVE PRODUCTS.

WITHOUT LIMITATION OF THE FOREGOING, TO THE FULLEST EXTENT POSSIBLE UNDER APPLICABLE LAWS, HENKEL EXPRESSLY DISCLAIMS ANY LIABILITY WHATSOEVER FOR ANY DAMAGES INCURRED DIRECTLY OR INDIRECTLY IN CONNECTION WITH THE SALE OR USE OF, OR OTHERWISE IN CONNECTION WITH, THE PRODUCTS, INCLUDING, WITHOUT LIMITATION, LOSS OF PROFITS AND SPECIAL, INDIRECT OR CONSEQUENTIAL DAMAGES, WHETHER CAUSED BY NEGLIGENCE FROM HENKEL OR OTHERWISE.

Henkel Corporation
One Henkel Way
Rocky Hill, CT 06067-3910
USA

Henkel Canada Corporation
2225 Meadowpine Boulevard
Mississauga, Ontario L5N 7P2
CANADA

Henkel Corporation
Automotive/ Metals H.Q.
32100 Stephenson Hwy,
Madison Heights 48071
USA

Henkel Capital, S.A. de C.V.
Calzada de la Viga s/n Fracc. Los
Laureles
Loc. Tulpetlac, C.P. 55090
Ecatepec de Morelos, MEXICO

Henkel Singapore Pte Ltd
Blk 5002 Ang Mo Kio Ave 5
#03-12 TECHplace 2, 569871
SINGAPORE

Henkel (China) Company Ltd.
No. 928 Zhang Heng Road,
Zhangjiang, Hi-Tech Park, Pudong,
Shanghai, China 201203

Henkel Loctite Korea
8F, Mapo Tower, 418,
Mapo-dong, Mapo-gu,
Seoul, 121-734, KOREA

Henkel Japan Ltd.
27-7 Shin Isogo-cho, Isogo-ku
Yokohama, 235-0017
JAPAN

www.equipment.loctite.com

Loctite is a trademark of Henkel Corporation, U.S.A. © Copyright 2006. Henkel Corporation
Teflon is a registered trademark of E.I. DuPont de Nemours Co., Inc.
All rights reserved. Data in this operation manual is subject to change without notice.
Manual P/N: 8902415 Date: 08/2010

